

User Instructions

Floor standing oil fired condensing boiler conventional flue and room sealed flue

Greenstar Danesmoor Utility Regular ^{ErP} and Utility System ^{ErP} 12/18, 18/25 & 25/32

For fully pumped open vent and sealed central heating systems and domestic hot water cylinders.
For use with Kerosene (Class C2) only.

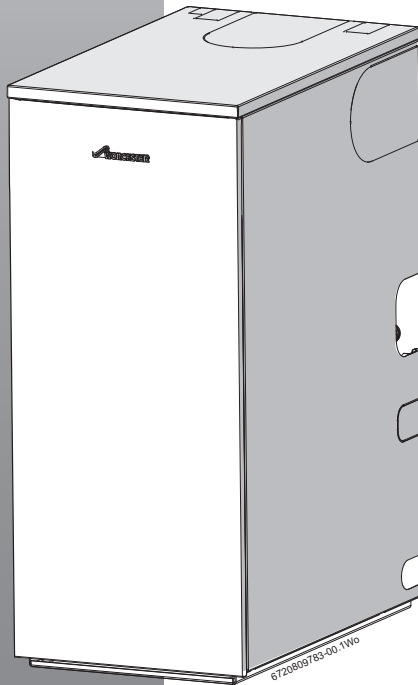

UK

Preface

Please read these instructions carefully

These instructions are applicable to the Worcester, Bosch Group appliance model stated on the front cover only.

These instructions apply in the UK only and must be followed except for any statutory obligation.

After installation please leave this User instruction Manual, Installation, Commissioning and Servicing Instructions and completed Benchmark Checklist with the user.

Dedicated to heating comfort

Thank you for purchasing a Greenstar oil-fired condensing appliance manufactured by Worcester, Bosch Group. The company prides itself on manufacturing appliances to the strictest quality control standards throughout every stage of production.

Worcester, Bosch group has led the field in innovative appliance design and performance for over 50 years. This heritage means all our products are of exceptional quality and proven reliability.

The Greenstar range in particular is extremely energy efficient, offering you economical running costs and value for money. It is amongst the top energy rated appliances available.

There is also the reassurance of our parts and labour guarantee - backed up by Worcester Total Cover, an optional complete maintenance scheme to keep your appliance operating at peak condition and efficiency.

Contents

1	Key to symbols and safety instructions	3
1.1	Key to symbols	3
1.2	Safety instructions	4
2	General Information	4
2.1	Energy efficiency	4
2.2	Servicing	4
2.3	User caution	4
3	Using your boiler	5
3.1	Controls	5
3.2	Operating the boiler	6
3.2.1	Switching the boiler on/off	6
3.2.2	Setting the heating temperature	6
3.2.3	Controlling the central heating	6
3.2.4	Frost protection	6
4	Maintenance	7
4.1	Maintaining your boiler	7
4.2	Servicing	7
5	External filling loop (sealed system only)	8
6	General information	9
6.1	Ventilation information	9
6.2	Maintenance clearances	9
6.3	General notes	9
7	Fault finding	10
7.1	Fault conditions	11
8	Fault or Breakdown	12
9	Energy saving	13
9.1	Tips on energy saving	13
10	Your guarantee	14
11	Environment/disposal	14

1 Key to symbols and safety instructions

1.1 Key to symbols

Warnings

	<p>Safety instructions in this document are framed and identified by a warning triangle which is printed on a grey background.</p>
--	--

The following keywords are defined and can be used in this document:

- **NOTICE** indicates a situation that could result in damage to property or equipment.
- **CAUTION** indicates a situation that could result in minor to medium injury.
- **WARNING** indicates a situation that could result in severe injury or death.
- **DANGER** indicates a situation that will result in severe injury or death.

Important information



This symbol indicates important information where there is no risk to people or property.

Additional symbols

Symbol	Meaning
1.	a numbered step in an action sequence
▶	a step in an action sequence
→	a reference to a related part in the document or to other related documents
①	a reference number to identify or refer to a part or item
•	a list entry
–	a list entry (second level)

Table 1

Examples of additional symbols used

A numbered step in an action sequence

A sequence of numbered steps or actions carried out in a specific order to complete a task.

1. First action
2. Second action
3. Third action
- etc.

A step in an action sequence

A sequence of defined actions or steps carried out in order to complete a task.

- ▶ Action
- ▶ Next action
- ▶ etc

A reference to a related part in the document or to other related documents.

To refer the reader to a specific figure/table/section within the manual.

→ e.g. figure 1.

A reference number to identify or refer to a part or item.

In a related figure, items or parts identified by a sequential number.

List entries, first and second levels

- A single component/item
- A component/list, made up of multiple parts/items.
 - Sub component or sublist of main component/list.
 - etc.

1.2 Safety instructions

These operating instructions are intended for the user of the heating system.

- ▶ Read any operating instructions (boiler, heating controls, etc.) carefully before operation and keep them.
- ▶ Observe the safety instructions and warnings.

Oil fumes or leaks from the appliance

If you smell oil fumes, observe the following rules.

- ▶ Extinguish any naked flames
- ▶ Isolate the electrical supply
- ▶ Isolate the fuel supply to the boiler
- ▶ Open windows and doors
- ▶ Rectify the fault

Health and safety

The appliance contains no asbestos and no substances have been used in the construction process that contravene the COSHH Regulations (Control of Substances Hazardous to Health Regulations 1988). Where applicable, the CE mark indicates compliance with relative EU Directives.

Combustion air/room air

The air in the installation room must be free of combustible or chemically aggressive substances.

- ▶ Do not use or store combustible or explosive materials (paper, propellants, thinners, paints, etc.) within the vicinity of the appliance.
- ▶ Do not use or store corrosive substances (solvents, adhesives, chlorinated cleaning agents, etc.) within the vicinity of the appliance.

Appliance operation:

This appliance can be used by children aged from 8 years and above and persons with reduced physical, sensory or mental capabilities or lack of experience and knowledge, if they have been given supervision or instruction concerning the use of the appliance, in a safe way, and understand the hazards involved.

Children shall not play with the appliance.

Cleaning and user maintenance shall not be made by children without supervision.

Intended use

This appliance must only be used as a heat appliance in a sealed hot water heating system for domestic purposes.

Any misuse or unauthorised modifications to the appliance, flue or associated accessories and heating system will invalidate the guarantee.

- Do not modify the appliance or flue system in any way.

Worcester, Bosch Group accepts no liability arising from any such actions. This does not affect your statutory rights.

2 General Information

2.1 Energy efficiency

Energy efficiency information is given in the Installation, Commissioning and Servicing Instructions supplied with the appliance.

2.2 Servicing

The Service Checklist can be found at the rear of the boiler's installation instructions. It will be required in the event of any guarantee work and may be required by the local Building Control Inspector.

- ▶ Have the boiler serviced regularly by a competent, OFTEC registered engineer.
- ▶ Ensure that the service engineer completes the Service Record, at the rear of the Installation, Commissioning and Servicing Instruction manual, after each service.
- ▶ Have any work carried out only by a competent, OFTEC registered engineer.
- ▶ Always use original spares, to help maintain the efficiency, safety and reliability of the appliance.

2.3 User caution

- It is forbidden for any interference with the appliance other than those actions allowed in this document.



CAUTION: Incorrect use

- ▶ Any incorrect use can result in danger to the householder.

3 Using your boiler

3.1 Controls

1. Temperature control (behind front panel [5])
2. Reset button - Flue overheat thermostat (behind front panel [5])
3. Control panel (behind front panel [5])
4. Reset button - Boiler overheat thermostat (behind front panel [5])
5. Front panel
6. Lockout reset button on burner control box (behind front panel [5])

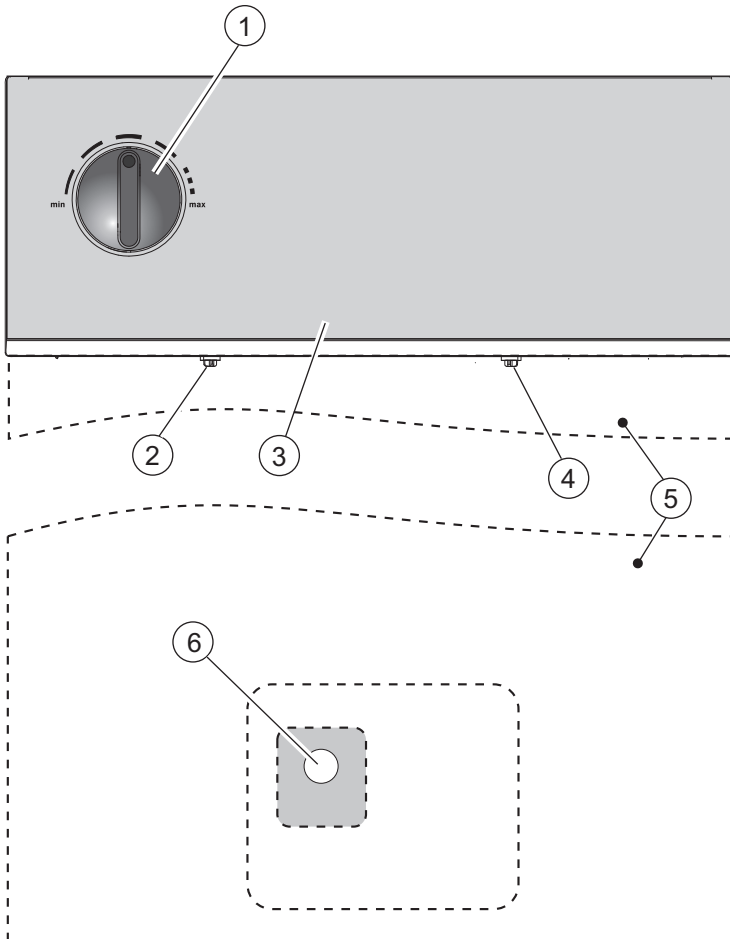

67208097/83-01.1W6

3.2 Operating the boiler

3.2.1 Switching the boiler on/off

- ▶ To switch on the boiler; turn on the water, oil and electricity supply to the boiler.
- ▶ Check the programmer/timer is correct and is set to ON.
- ▶ Set the room thermostat to the desired setting.
- ▶ Open and set thermostatic radiator valves as required.
- ▶ Turn the boiler water temperature control to the required setting.
- ▶ To switch off the boiler; turn the programmer/timer to OFF for heating and hot water.

If the boiler is left unused and exposed to freezing conditions; shut off all the mains supplies, isolate the boiler and drain the system and boiler.

3.2.2 Setting the heating temperature

- ▶ Turn the control clockwise to increase the water temperature.
- ▶ Turn the control anti-clockwise to reduce the water temperature.

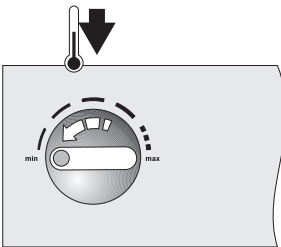
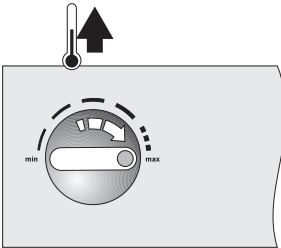

6720809783-02.1W6

The minimum and maximum ranges of the temperature control positions are approximately 55°C to 81°C.

3.2.3 Controlling the central heating

- ▶ Set the programmer/timer to the correct time with the required ON/OFF periods.
- ▶ Turn the room thermostat to the temperature required.
- ▶ Set thermostatic radiator valves to the required temperature for each room.

3.2.4 Frost protection

- ▶ Frost thermostats can be wired into the boiler.
- ▶ Frost protection should be fitted to the system where the system is most exposed and at risk of freezing.



If there is no hot water or heating, check page 10 and 11 for fault condition guidance.

4 Maintenance

4.1 Maintaining your boiler

Your new boiler represents a long term investment in a reliable, high quality product.

In order to realise its maximum working life and to ensure it continues to operate at peak efficiency and performance, it is essential that servicing and maintenance checks are performed at least once a year by an OFTEC engineer or other suitably qualified person.

If you would like to know more about servicing options from Worcester, Bosch Group, please visit worcester-bosch.co.uk. Please tick the appropriate box on your warranty registration card for further details of the Worcester, Bosch Group Service Contract.

When your boiler requires servicing please contact a Worcester, Bosch Group contact centre (see the back cover for details).

In addition to the service contract we are pleased to offer a one-off annual service or breakdown call out for your boiler.

Maintenance tips:

- Regularly check the oil level in the tank
- Do not obstruct the flue outlet or the air inlet
- Regularly check the system pressure gauge [D], see the figure below and chapter 4 for instructions on re-pressurisation of your system boiler.

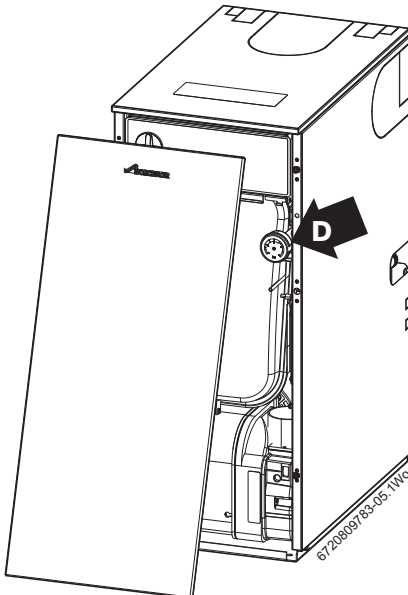

Use in hard water areas

In exceptionally hard water areas a device to prevent scale formation may be fitted. Installation of a scale inhibitor assembly should be in accordance with the requirements of the local water company.

An isolating valve should be fitted to allow for servicing.

4.2 Servicing

You must have the boiler regularly serviced by a competent, qualified OFTEC registered engineer using approved spares, to help maintain the economy, safety and reliability of the boiler. The boiler should be serviced once each year after installation unless the installation conditions and usage demand more frequent services.



Ensure that the service engineer completes the Service Record in the checklist after each service.

The completed checklist will be required in the event of any warranty work and may be required by the local Building Control Inspector.

The checklist and service interval record can be found at the rear of the Installation, Commissioning and Servicing Instructions.

5 External filling loop (sealed system only)

This appliance is fitted to a sealed heating system which is pressurised. Your installer will advise you of the minimum and maximum pressure indicated on the pressure gauge.

- ▶ Check regularly that the pressure is maintained.
- ▶ If the pressure gauge reads less than 1 bar then the system requires re-charging.
- ▶ Contact your installer or maintenance engineer if a permanent significant decrease or increase in pressure is indicated on the pressure gauge.

Once the external filling loop has been located, follow the instructions for re-pressurising the system.

1. Unscrew blanking cap.
2. Attach the hose to the valves, screw on hand-tight.
3. Turn the handle/screwdriver slot through 90° to open the valves.
4. The handle/screwdriver slot will be in-line with the valves

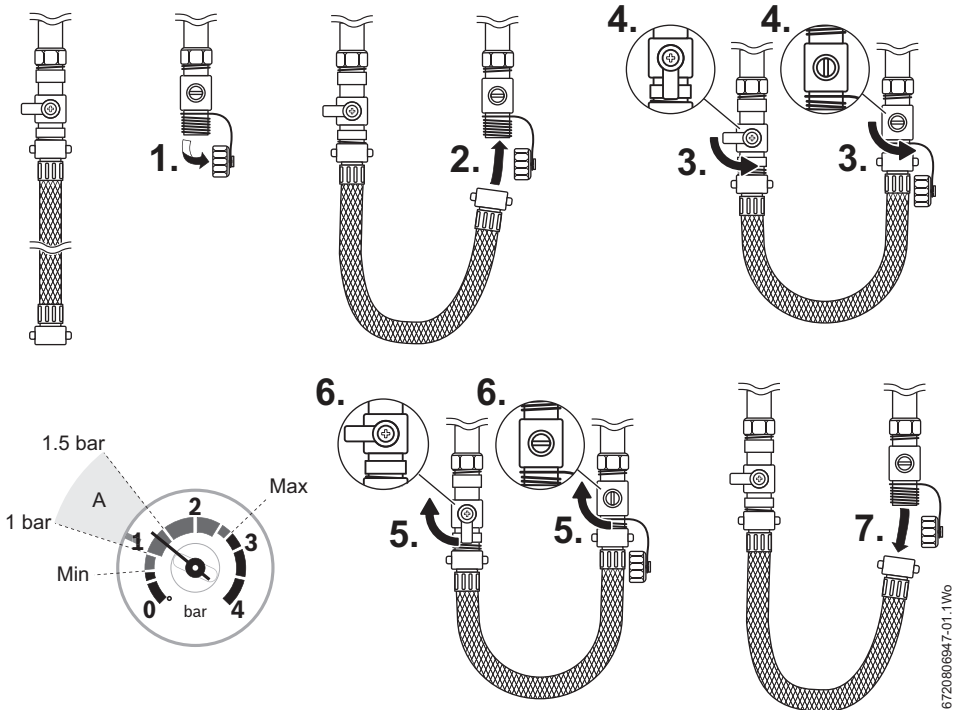

Fig. 1 External filling loop

5. When the pressure reaches between the 1 and 1.5 bar marks (zone A), turn the handle/screwdriver slot back, through 90°, to close the valve.
6. The handle/screwdriver slot will be at 90° to the valves
7. Remove the hose and replace the blanking caps.

If the pressure gauge reads more than 1.5 bar as a result of over filling, bleed one radiator until the pressure gauge returns to between 1 and 1.5 bar.

6 General information

6.1 Ventilation information

Boiler location

** The boiler can be installed under a worktop as long as:

- ▶ The worktop above the boiler is easily removable for maintenance.
- ▶ There is at least 10mm clearance above the boiler.
- ▶ The front of the boiler is not enclosed.

Ventilation

Air vents must be functional at all times and the air supply must not be restricted or contaminated.

The boiler clearances must meet the minimum shown below for servicing and venting purposes.

* If this clearance is less than 75mm the flue 'knock-out' panel sections must be removed to improve air circulation and cooling.

Do not place clothes or objects to hinder the air circulation required by the boiler.

6.2 Maintenance clearances

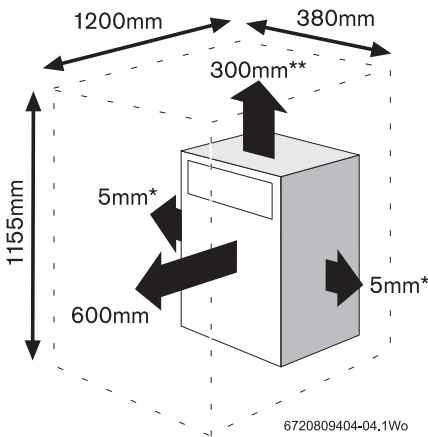

Conventional flue boilers require an adequate supply of fresh air which must be delivered to the boiler for combustion purposes through a permanent inlet, such as an air brick, into the area where the boiler is situated.

If a cupboard or compartment which is to be used for storage or airing is built around the boiler after installation there must be a non-combustible partition around the boiler. Refer to the installation manual for minimum vent sizes.

6.3 General notes

To get the best from your boiler, read these instructions carefully.

Central heating system

During the first few hours of operation of the central heating system, check that all radiators are being heated at an even rate. If the top of a radiator is at a lower temperature than the bottom then it should be vented by releasing air through the venting screw at the top of the radiator. Ask your installer to show you how this is done. Repeated venting will reduce the quantity of water in the system and this must be replenished for safe and satisfactory operation of the boiler.

When excessive venting or water leaks are found in the system you must contact a service engineer to inspect the installation and rectify any fault.

Only use additives compatible with the boiler and system. Use of incompatible additives can cause damage and will invalidate the boiler guarantee.

Condensate drain

This is a condensing boiler and the terminal will, at times give out a plume of water vapour. This is quite normal.

The boiler also produces quantities of condensate which is discharged regularly via a pipe to drain.

This pipe must not be blocked or altered in any way.

Clearances, see section 6.2

Your installer will have provided adequate space around the boiler for safety and servicing access.

Do not restrict this space with the addition of cupboards, shelves etc. next to the boiler.

Room thermostat

A room temperature controller must be fitted to control the central heating. Refer to instructions supplied with the thermostat for information on siting and setting.

Thermostatic radiator valves

It is recommended that this type of valve is fitted to all but one of the radiators (or at least those in the sleeping accommodation). The remaining radiator, which must be where the room thermostat is located, should be un-controlled and must be left open.

7 Fault finding

In the event that the appliance stops functioning or does not perform as expected, you can carry out a few simple checks. These checks are some of the most common causes and are listed in the table below. Should the problem persist or if other fault codes are displayed, then it will be necessary to contact Worcester, Bosch Group.

Problem	Cause	Remedy
Desired room temperature is not reached	Thermostatic radiator valve(s) set too low	▶ Increase thermostatic radiator valve setting(s).
	Temperature control for central heating flow on boiler set too low	▶ Increase central heating flow temperature control setting
	Low temperature setting on the room thermostat	▶ Increase settings on room thermostat
	Air trapped in heating system (System model)	▶ Bleed radiators and re-pressurise the heating system
	Low system water pressure (System model)	▶ Re-pressurise the system, refer to page 8
Desired room temperature is too high	Thermostatic radiator valve(s) are set too high	▶ Turn down thermostatic radiator valves/room thermostat
	Room thermostat is set too high	▶ Reduce central heating temperature by turning down the Central Heating control on boiler
Heating stays on for too long	Clock is incorrectly set	▶ Check setting and adjust
Hot water temperature too low	Temperature set too low on cylinder thermostat control.	▶ Check setting and adjust
	Air trapped in heating system (System model)	▶ Bleed radiators and re-pressurise the heating system
	Low system water pressure (System model)	▶ Re-pressurise the system, refer to page 8
Hot water temperature too high	Temperature set too high on cylinder thermostat control.	▶ Check setting and adjust

Table 2 Fault finding

7.1 Fault conditions

Normal operation

1. Lockout indicator OFF:

- ▶ The burner will cycle on and off under the control of the programmer/timer and the thermostats.

Lockout indicator light

2. Lockout light ON, boiler not firing:

- ▶ Check oil level in the oil storage tank.
- ▶ Press button (A). Boiler should fire.
- ▶ If no response, wait 2 minutes - press reset button (A) again.
- ▶ If lockout light stays on, do not attempt further resets. Contact your service engineer for advice.

3. Lockout light OFF, boiler not ON, no heating/hot water

- ▶ Ensure there is a power supply to the boiler.
- ▶ Check the programmer is set to ON for heating.
- ▶ Check the setting of the room thermostat, boiler temperature control/tank thermostat.
- ▶ Press reset buttons (B and C).
- ▶ If the demand light stays off contact your service engineer for advice.

To access the reset buttons

- ▶ Pull front panel off boiler to release ball stud connections.
- ▶ Reset buttons and lockout indicator positions shown opposite.
- ▶ To replace front panel, locate ball studs in their connectors and push. Apply pressure to the edges of the panel only to avoid possible damage.

1), 3)

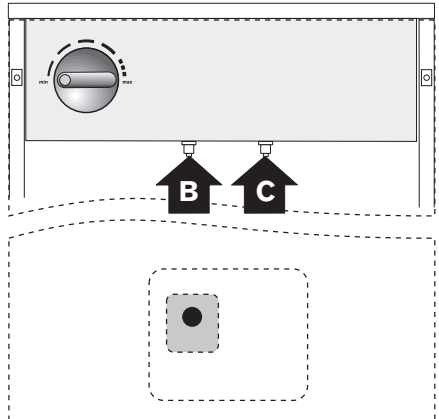

2)

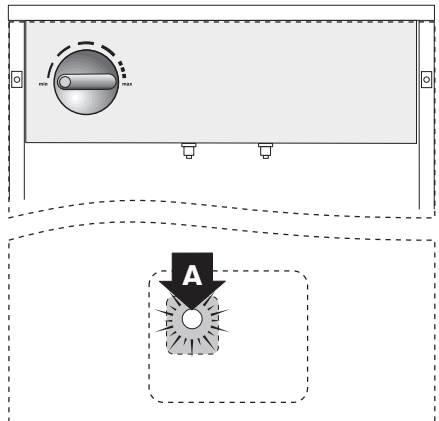

ACCESSING RESET BUTTONS:

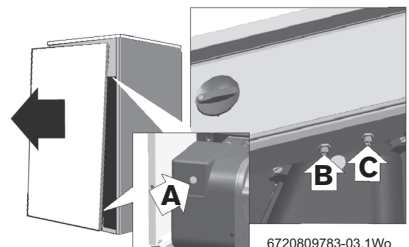

6720809783-03.1Wo

8 Fault or Breakdown

This boiler is supported in mainland UK by Worcester, Bosch Group, part of Bosch Thermotechnology Ltd.

Specialist service engineers are available to attend a breakdown occurring on this appliance.



Invoices for attendance and repair work carried out on this appliance by any third party will not be accepted.

- No charge will be made for parts and/or labour providing: An appliance fault is found and the appliance is within the guarantee period. Reasonable evidence of this must be supplied on request. i.e. the Benchmark Checklist.
- A call-out charge will be made where:
 - The appliance is outside the guarantee period.
 - Evidence cannot be provided that the first year service inspection has been carried out (i.e. an entry in the Benchmark Checklist).
 - Our Field Service Engineer finds no fault with the appliance.
 - The cause of breakdown is misuse or with other parts of your plumbing/heating system, or with equipment not supplied by Worcester, Bosch Group.

If the boiler fails to give complete satisfaction, please check the following points before calling for a service engineer:

1. Oil level in the tank
2. Power to the boiler
3. All control settings

Technical support



No appliance fault is found on over 30% of all service calls.

In the case of a suspected fault, refer to the fault finding section of this guide.

In the event of a appliance fault or breakdown please contact Worcester, Bosch Group appointments team on 0330 123 9339.

Your advisor will arrange for an engineer to call with the minimum of delay; under normal circumstances this will be from 1 - 3 working days (excluding weekends and bank holidays) for priority breakdown situations (no hot water and/or heating).

Boiler data label

The data label can be found on the condensate trap bracket on the right hand side.

To access first remove the front panel:

- ▶ Pull bottom of front panel to release lugs.
- ▶ Lift panel off top ledge (beneath the fascia) and remove from appliance.

To replace front panel:

- ▶ Hang the front panel on the top ledge.
- ▶ Gently push the panel at the base (from the edges so as not to damage the panel) until the panel clips into place.

(You can record this information on the inside back cover of this manual.)

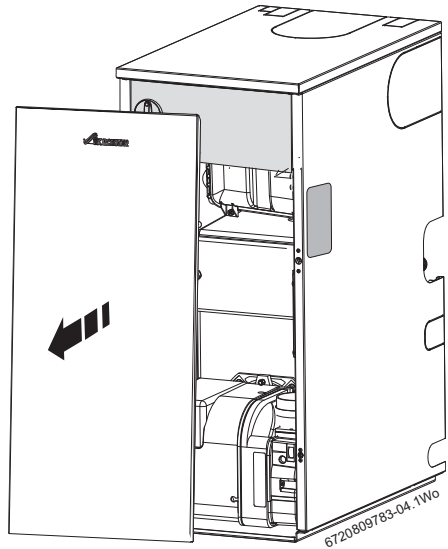

9 Energy saving

9.1 Tips on energy saving

Room thermostats

Reducing the setting of the room thermostat by 1°C can reduce fuel consumption by up to 10%.

New control systems

Upgrade your heating control system with the latest equipment available. The minimum level of control for a heating system is a programmer, interlocking room thermostat and thermostatic radiator valves.

Radiators

More often than not radiators will be sited underneath a window, so the warm air from the radiator heats the colder incoming air from the window.

The performance of the radiator will be affected if the curtains are allowed to drape over the radiator or shelves are fitted above it.

The positioning of furniture and tables in front of the radiator should also be avoided.

It is advisable to manually adjust all radiator valves every 2-3 months to prevent them from sticking. It is also important that the plastic tops of all valves are always in position and not cracked or damaged to help prevent accidents. Care should be taken when vacuum cleaning carpets to avoid damage to valves and pipework.

The heating system and the outputs of the radiators have been carefully selected by your installer. The temperature obtainable in any given room is dependent on all radiators being operated at the same time. If you decide to turn off radiators in unused rooms, spare bedrooms etc., you may experience slightly lower room temperatures in rooms adjacent to unheated rooms.

Heating economically

The boiler is designed to provide a high level of comfort while keeping oil consumption and the resulting environmental effect as low as possible.

The central heating control on the boiler should be set as low as possible while still maintaining a comfortable room temperature.

The temperature of each room can be set individually using the thermostatic radiator valves (except the primary room with the room thermostat).

Roof insulation

Around 30% of the heat loss from a property is through the roof. Replace any old insulation with new insulation, preferably to a minimum thickness of 200mm.

Window frames

Single glazed windows, particularly those with steel frames, can lose a great deal of heat.

Consideration should be given to replacement with PVCu or wooden framed double glazed units.

Curtains

Lined curtains, or heavier full length curtains can provide excellent insulation. However, always ensure that the curtains do not drape over radiators.

Draughts

Try to ensure that draughts around doors, windows, letter boxes and keyholes etc. are reduced by using a suitable draught excluder.

10 Your guarantee

This appliance has a guarantee against faulty materials or workmanship from the date of installation subject to the following terms and conditions:

- During the period of this guarantee any components of the appliance which are proven to be faulty or defective in manufacture will be exchanged or repaired free of charge by Bosch Thermotechnology Ltd.
- The householder may be asked to prove the date of installation, that the appliance was correctly commissioned and, where appropriate, the first year's service has been carried out to the satisfaction of Bosch Thermotechnology Ltd., when requested. These should be documented as a part of the Benchmark Checklist.
- The appliance has been used only for the normal domestic purposes for which it was designed.

This guarantee does not affect your statutory rights.

Guarantee registration

Your Greenstar appliance carries a guarantee against faulty material or manufacturer subject to Terms and Conditions. To read the full Terms & Conditions please visit us on-line at www.worcester-bosch.co.uk/guarantee. The Guarantee Registration form is available on this same page and can be completed and submitted electronically.

Alternatively, please telephone one of our Guarantee Registration advisors on 0330 123 2552.

Your statutory rights are not affected by the manufacturers guarantee.

For you records:

Model	
Serial number*	
Type/size	
Date of installation	
Installer details	

[*] Refer to the boiler data label inside the casing

11 Environment/disposal

Environmental protection is a fundamental corporate strategy of the Bosch Group.

The quality of our products, their economy and environmental safety are all of equal importance to us and all environmental protection legislation and regulations are strictly observed.

We use the best possible technology and materials for protecting the environment taking account of economic considerations.

Packaging

We participate in the recycling programmes of the countries in which our products are sold to ensure optimum recycling.

All of our packaging materials are environmentally compatible and can be recycled.

Notes

Worcester, Bosch Group
Cotswold Way, Warndon, Worcester WR4 9SW.
Tel. 0330 123 9559
Worcester, Bosch Group is a brand name of
Bosch Thermotechnology Ltd.

worcester-bosch.co.uk

6 720 813 725 (2014/09)

WORCESTER, BOSCH GROUP:

TECHNICAL SUPPORT:	0330 123 3366
APPOINTMENTS:	0330 123 9339
SPARES:	0330 123 9779
LITERATURE:	0330 123 9119
TRAINING:	0330 123 0166
SALES:	0330 123 9669



WORCESTER
Bosch Group